

eti[®] NETCOM[®] EDH-4

INSTALLATION & OPERATION MANUAL



SAFETY INFORMATION AND WARNING SUMMARY	1
GLOSSARY	2
INTRODUCTION	2
Purpose of EDH-5 Description	
INSTALLATION	3
Unpacking/Packing	
Inventory List	
Additional Equipment Required for Installation Initial Inspection	
Location of Installation	
Mounting the EDH-5	
PREPARATION AND SYSTEM SET-UP	5
Principal Considerations Power Connection Pneumatic Connection	
OPERATION	6
Control	
Information Display	
OPERATING PROCEDURES	7
Automatic Operation Alarm Relays	
EMERGENCY PROCEDURES	8
Abnormal Smoke or Odor Ruptured Feed Window	
TECHNICAL DESCRIPTION	9
Electronic Pneumatic	
Theory of Operation	
MAINTENANCE	9
Periodic Maintenance Renewing the Desiccant	
Regenerating the Desiccant	
SPECIFICATIONS	13
TROUBLESHOOTING	14
RETURNS AND REPLACEMENT PARTS PURCHASES	15
Replacement Parts List	
ORDERING INFORMATION	15

SAFETY INFORMATION AND WARNING SUMMARY

Read and become familiar with the safety information below.



Lethal Voltages Present

There are lethal voltages present inside the case of the EDH-4. Service should be performed by qualified personnel only. There are no user serviceable components inside the chassis. Ensure the EDH-4 is reliably grounded.

Tensions létales présentes

Des tensions mortelles sont présentes à l'intérieur du boîtier de l'EDH - 4. Le service doit être effectué uniquement par du personnel qualifié. Il n'y a aucun composant réparable par l'utilisateur à l'intérieur du châssis. Assurez-vous que l'EDH - 4 est correctement mis à la terre.



Abnormal Odor or Smoke

In the event of smoke or an abnormal odor, immediately interrupt power to the EDH-4. Disconnect the unit from its power source or trip the circuit breaker controlling the outlet.

Odeur ou fumée anormale

En cas de fumée ou d'odeur anormale, coupez immédiatement l'alimentation de l'EDH - 4. Débranchez l'appareil de sa source d'alimentation ou déclenchez le disjoncteur contrôlant la prise.



Pneumatic Pressure Hazard

Always vent the system to atmospheric pressure before servicing pneumatic components.

The air pumps in the EDH-4 Air Dehydrator are capable of generating as much as 1.2 psig (82.7 mbar). Proper safety practice requires treating all pneumatic components with care.

Risque de pression pneumatique

Purgez toujours le système à la pression atmosphérique avant de procéder à l'entretien des composants pneumatiques. Les pompes à air du déshydrateur d'air EDH - 4 peuvent générer jusqu'à 1,2 psig (82,7 mbar). Une bonne pratique de sécurité nécessite de traiter tous les composants pneumatiques avec soin.



Operating Temperature

Verify adequate air flow and power supply capacity is available to the EDH-4.

Ensure that the EDH-4's maximum operating temperature of 130°F (55°C) will not be compromised by other components in its environment.

Température de fonctionnement

Vérifiez que l'EDH - 4 dispose d'un débit d'air et d'une capacité d'alimentation électrique adéquats. Assurez-vous que la température de fonctionnement maximale de l'EDH - 4 de 130 ° F (55 ° C) ne sera pas compromise par d'autres composants de son environnement.



Mounting

Before and after mounting the EDH-4, ensure that the mounting surface is stable. Mounting the EDH-4 should be such that a hazardous condition is not created due to uneven mechanical loading. Verify that adequate air flow and power source capacity is available to the unit.

Montage

Avant et après le montage de l'EDH - 4, assurez-vous que la surface de montage est stable. Le montage de l'EDH - 4 doit être tel qu'aucune condition dangereuse ne soit créée en raison d'une charge mécanique inégale. Vérifiez que le débit d'air et la capacité de la source d'alimentation sont disponibles pour l'unité.

GLOSSARY

Listed below are some important terms and their definitions.

SOLAR GAIN

Generally occurring each day at sunrise, the time when sunlight and heat increase, resulting in a natural corresponding rise in temperature and pressure inside a cable line. Solar gain can also occur before or after a major weather event.

VSWR

VSWR means Voltage Standing Wave Ratio and is used to measure the amount of energy that is reflected back into the transmitter from the antenna when the antenna is not tuned properly. Water in the transmission line will de-tune the antenna and cause a higher VSWR.



INTRODUCTION

Please read this manual for information on the EDH-4 prior to installing, operating or servicing the unit.

PURPOSE OF EDH-5

The EDH-4 Air Dehydrator maintains waveguides, air dielectric coaxial cable and other related components used in earth stations, terrestrial UHF, microwave communication systems and the like. It prevents the accumulation of moisture in

dielectric lines by maintaining optimal pressure and humidity of the air in the line. The EDH-4 enhances the reliability of a station's signal output through supplying low pressure dry air.

The EDH-4 is intended for use in small volume C, X, Ku and Ka band applications. For larger applications, please contact Customer Service for information on the ADH NETCOM family of automatic air dehydrators.

Unpressurized dielectric transmission lines allow the entry of moist ambient air through leaking seals, penetrations and cracks. Consider the line passing from one environment to another, such as when entering a shelter from the antenna outside. Perhaps there is a change in existing external ambient conditions, such as a weather front, or nightfall. These pressure and/or temperature changes in the air supply may lead to moisture condensation within the transmission environment. This is normally the result of the ambient temperature dropping below the dew point. Water in transmission lines causes corrosion, voltage arcing and increased voltage standing wave ratio (VSWR). These conditions reduce system performance.

DESCRIPTION

The EDH-4 Air Dehydrator is an economical, manually regenerative air dehydrator for waveguide environments. Air is pressurized by a twin head vibratory pump and then dehydrated by passing it through an absorption unit containing a drying agent. The dried air is then delivered to the communications equipment through a 1/4" (6.35 mm) hose barb fitting. The EDH-4 works best supplying dry air in a flowing system, where the dehydrator completely replaces the air on a regular basis.

The EDH-4 provides dry air regulated between 0.3 psig (20.7 mbar) and 0.5 psig (34.5 mbar), delivering 6.0 standard cubic feet of air per hour (2.8 l/m). Under normal conditions, the output dew point of the air is -40°C.

Physically, the EDH-4 occupies a space 11.625" wide x 7.0" deep x 4.814" high (295.3 mm wide x 177.8 mm deep x 122.3 mm high); three spaces of a standard relay rack.

Pressure display is user selectable to International Symbol of Units (Le Système International d'Unités, or SI) or English customary units. Both pressure and alarm information are shown on a wide viewing angle LED digital display. The EDH - 4 makes use of two alarm relays. The first alarm relay is a renew desiccant alarm; the second alarm relay indicates one or more alarms. The desiccant contains an orange coating which turns white when the desiccant requires renewal.

The moisture is removed from the drying agent manually. Users must manually renew or replace the desiccant as required. This operation is needed typically every six months to two years, depending on system leakage and environmental conditions.

INSTALLATION

UNPACKING / PACKING

Unpacking/Packing

Immediately inspect the shipping container and packing material for damage. Unpack the EDH-4, taking care not to damage the cushioning materials. Save the shipping container and related materials until normal operation has been established.

INVENTORY LIST

Verify that the package contains the parts listed for EDH-4 version ordered.

EDH-4

QUANTITY	PART NO.	DESCRIPTION
1	18021	EDH-4 Dehydrator
1	24976	Power Cord Assembly
1	25415	EDH-4 Installation Sheet
-	18063	EDH-4 Installation & Operation Manual (this document) Available online at: networketi.com/product-manuals
2	23245	Mounting Bracket
2	25007	Mounting Bracket, Wide

FIGURE 1.
EDH-4's
rechargeable
or replaceable
desiccant

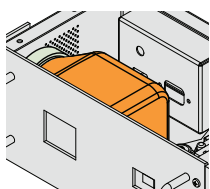

FIGURE 2.
EDH-4 Components



ADDITIONAL EQUIPMENT REQUIRED FOR INSTALLATION

The EDH-4 comes equipped standard with a 1/4" hose barbed fitting which accepts 1/4" ID (inside dimension) flexible tubing. Special fittings and tubing can be purchased from ETI; contact Customer Service for details.

INITIAL INSPECTION

Inspect the EDH-4 for electrical and mechanical damage. Contact the Customer Service Department if you find any of the following:

(continued on next page)

- Contents incomplete or incorrect per inventory list above
- Internal or external mechanical damage
- Desiccant is white (fully charged with moisture; refer to page 13 for renewal procedure)
- Defective operation; to test effective operation:
 - 1 Attach power to the EDH-5
 - 2 Seal outlet (plug, thumb or kink in hose)
 - 3 Pump stops
 - 4 LED display reads between 30 and 50
 - 5 Remove "seal": LED display reads 0 (zero)
 - 6 Replace "seal": LED display once again reads between 30 and 50

LOCATION

The rack mounted EDH-4 should be located reasonably close to waveguide and power. It needs sufficient clearance around it to facilitate access to power, alarm relay and pneumatic connections.

The unit requires a relay rack panel space of 19" wide x 5.25" high (482.6mm wide x 133.4" high) for WIDE applications or 13.63" wide x 5.25" high (346.1mm wide x 133.4" high) for NARROW applications.

high) for NARROW applications. Because the EDH-4 seldom requires operator attention, consider locating it in the lower portion or extreme upper portion of the relay rack.

However, on those occasions when the EDH-4 requires operator attention for desiccant recharging or replacement, consider a location convenient for this action.

MOUNTING

Install this unit in compliance with National Electrical Code (NEC) and Canadian Electrical Code (CEC) standards, as well as all other local and applicable electrical codes for your area. Prior to beginning installation, make sure that the facility has properly sized electric service and breaker. For additional information regarding electrical ratings and facility power requirements, refer to the Specifications section of this manual.

The EDH-4 mounting brackets will accommodate fasteners up to 1/4 inch (6.3 mm) in diameter. The choice of anchors and companion hardware should be appropriate for the mounting surface. At least four anchors should be used and each should be capable of supporting a combined load of at least 5 pounds (2.4 kg). The locations of the mounting points are shown in Figure 3A, Narrow, and Figure 3B, Wide.

Figure 3A. EDH-4 Rack Dimensions: Narrow

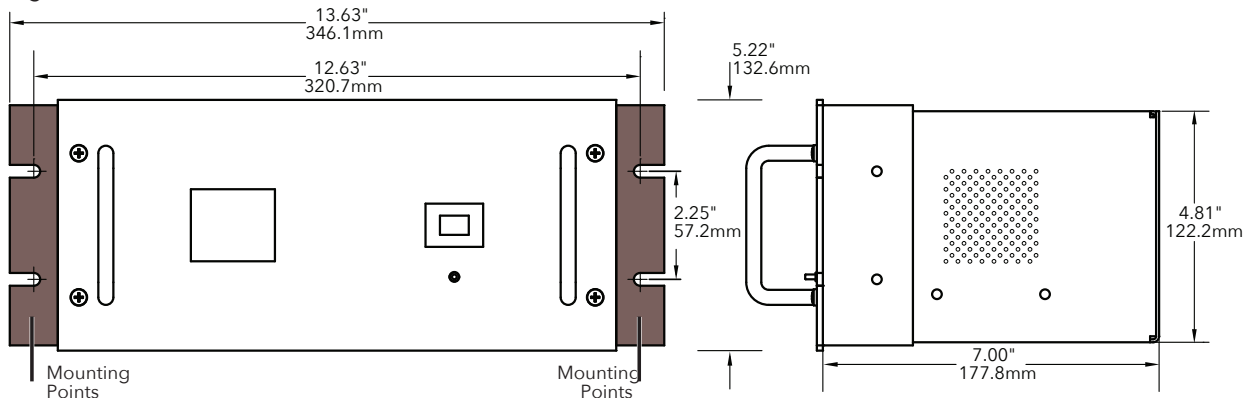

NOTE:

This unit produces a slight vibration due to oscillating components. This may lead to fatigue and possible failure of the mounting system or wall material. Please consider this when planning your installation.

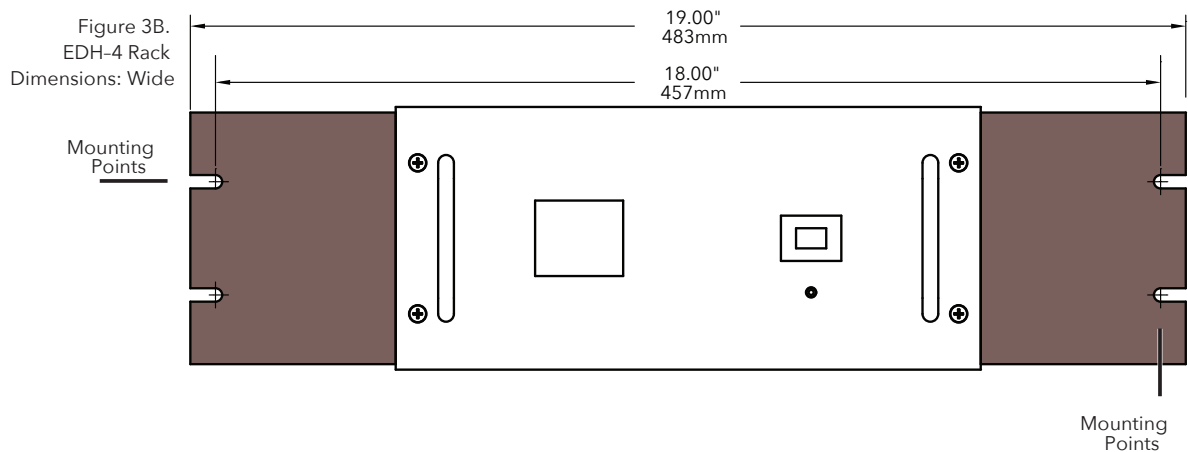

PREPARATION AND SYSTEM SET-UP

PRINCIPAL CONSIDERATIONS

The EDH-4 works best supplying dry air in a flowing system, where the dehydrator completely replaces the air on a regular basis. Consequently, the equipment being supplied dry air should be slightly leaky: that is, continual airflow is achieved when dry air pressure from the EDH-4 is greater than the air pressure of the environment the unit maintains. For a waveguide, this is best accomplished by slightly opening a purge valve at the window end of the system. Likewise, air dielectric coaxial cable should be equipped with a valve at the end opposite to where the EDH-4 pumps air, which can be set to allow a small leak. Many systems will have sufficient normal leakage that such actions will be unnecessary.

The EDH-4 also has a check valve in its air path. A tightly sealed system may experience a pressure increase, such as from solar gain, with a rise in ambient temperature. The EDH-4 has no way to reduce pressure buildup. A pressure relief valve rated to protect the feed horn

window is recommended to account for this buildup.

POWER CONNECTION

The EDH-4 uses a universal (100 VAC to 240 VAC at 50/60 Hz) power supply. This eliminates the need to set voltage during the installation or having to purchase different units for different power requirements.

The EDH-4 requires a standard outlet (North America: NEMA 5-15R) no further than 6 feet (1.8 m) from the power entry point at the back of the unit. Consider a readily accessible disconnect device and a short circuit and overcurrent device rated 20 amps maximum. The EDH-4 does not incorporate a power switch: the unit will be energized as soon as power is connected to the unit. The power cord contains a ground lead.

PNEUMATIC CONNECTION

The EDH-4 is supplied with a 1/4" (6.4 mm) barbed male fitting. Slip the supply tubing

over the outlet barb engaging all the ridges. The fit should be tight enough that a clamp or cable tie is not required although its use is recommended. Special accessories are available from Customer Service, including: distribution manifolds and a variety of pressure fittings and tubing types.

Figure 5.
EDH-4 Pneumatic Connections

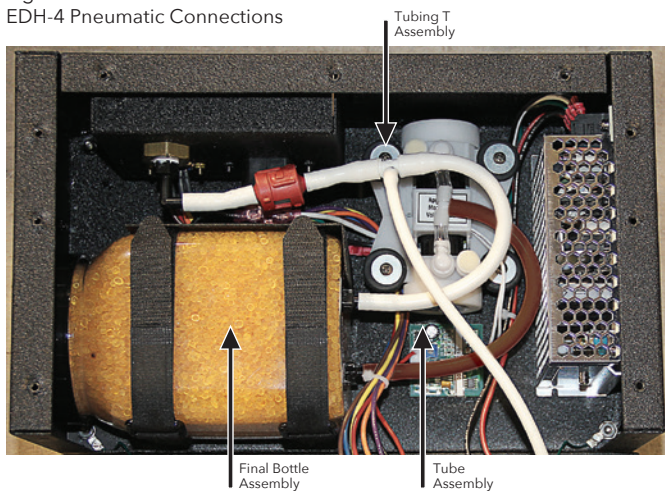

OPERATION

CONTROL

The EDH-4 makes use of a single switch called the Mode selector [MODE]. This is located just below the PRESSURE LED display window (Figure 6). [MODE] allows the user to

- Switch between English/imperial and metric units (press and hold [MODE]; metric displays ".")
- Display the percentage of desiccant remaining (quick press on and off)
- Desiccant timer re-set (power off, press and hold during power up).

INFORMATION DISPLAY

The front panel's "PRESSURE" display, a pair of seven-segment LED characters, reports pressure and status information.

The default display reports the air pressure level passing through the unit. Pressure may be displayed in either the default English customary units (hundredths of psig) or SI metric (mbar) units.

The display units may be switched by pressing and holding [MODE] for five (5) seconds. When units are set to English, the unit displays "99" for 0.99 psig, the maximum displayable pressure in English customary units. The maximum displayable pressure in SI units is 99 mbar, displayed as "99."-the decimal point displayed to the lower right of the numerals indicates mbar mode.

To assess the Percentage Desiccant Absorption Capacity remaining, quickly press and release [MODE]. The LED displays some number "nn" where nn is 2-digit percentage of absorption capacity. "99" = 99%/ new desiccant/full capacity; "51" is 51% capacity (and so forth); "00" = 0% left /desiccant regeneration required.

The LED display is used with [MODE] to reset the desiccant timer. Hold [MODE] during power-up; after LED initialization, the display reports "99"; release [MODE] to continue normal operation. [Note: What is actually measured is simply the number of hours the compressor is running. This is somewhat correlated with how much useful time is left to the desiccant. The software is written with the assumption that moist air moves through the EDH-4; if the relative humidity is low, the desiccant may last longer.]

In the event of an alarm condition, an alarm code will be displayed. See Table 1. If no alarm

conditions exist, only the system pressure will be displayed.

TABLE 1.
Alarm Codes

DISPLAY	ALARM
LP	Low Pressure
LE	Leaky System
cd	Change Desiccant
HF	Verify electronic enclosure temperature > 5°C
Un	EEROM unknown (uninitialized or corrupted)
CA	uncalibrated

FIGURE 6.
Figure 6. PRESSURE display window, MODE switch

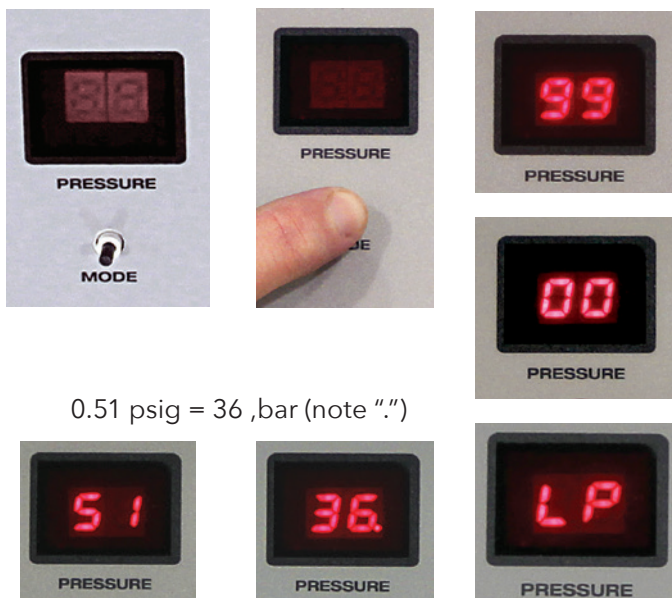

OPERATING PROCEDURES

AUTOMATIC OPERATION

The EDH-4 will commence operation when power is applied. The unit will automatically regulate the system pressure between 0.3 psig (20.7 mbar) and 0.5 psig (37.5 mbar).

ALARM RELAYS

The EDH-4 has two alarm relays; see Table 2 for pin out definition. One of the alarm relays is a pressure alarm (labeled "PRESSURE") and closes when any of the following conditions is met:

- Low pressure; the system pressure falls below 0.20 psig (13.8 mbar) for 25 continuous seconds.
- Excessive run time; the pump runs continuously for more than four hours.
- Low temperature within electronics housing; internal temperature falls below 5°C/41°F.

The summary alarm will continue as long as any of these conditions exists. When all conditions have been cleared, the alarm will reset. The second alarm relay closes when the renew desiccant timer signals a need to replace or regenerate the desiccant. This alarm is reset by depressing [MODE] during power up. Both relays close at power off.

TABLE 2. Alarm Relay Connector Pin Assignments

PIN	DESCRIPTION
1	Pressure Alarm Relay Normally Closed (NC)
2	Pressure Alarm Relay Common (COM)
3	Pressure Alarm Relay Normally Open (NO)
4	Desiccant Alarm Relay Normally Closed (NC)
5	Desiccant Alarm Relay Common (COM)
6	Desiccant Alarm Relay Normally Open (NO)

Note: Pins 7, 8 and 9 are not used

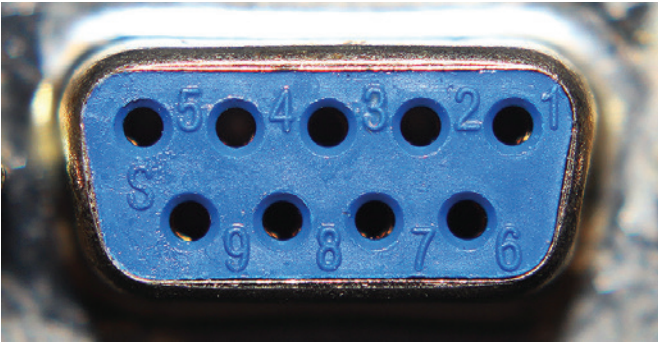

FIGURE 7. EDH-4 detail of DB-9 connector with pin numbers

EMERGENCY PROCEDURES

ABNORMAL SMOKE OR ODOR

Should abnormal smoke or odor arise, immediately interrupt the power to the unit by unplugging the unit or by tripping the breaker on the power circuit.

RUPTURED FEED WINDOW

Usually but not exclusively found in microwaves and parabolic antennas and satellite dishes, a small horn antenna—known as the feed horn (Figure 8)—is used to share radio waves between a transmitter/receiver/transceiver and a reflector. The opening of the feed horn, known as the feed (aperture) window, is usually sealed to help maintain the environment the EDH-4 conditions.

An error code of “LP” or “LE” on the PRESSURE display may indicate a ruptured feed window. This condition makes it impossible to maintain pressure in the system. Further, it is possible for water to flow into the waveguide or coaxial connections in the event of heavy rain. If this problem occurs, you will see a drop in output power and an increase in VSWR: IMMEDIATELY remove power from the EDH-4.

The EDH-4 will stop trying to pressurize a system if the compressor runs for four hours continuously. After repairing the leak, restore normal operation by momentarily interrupting power to the unit.

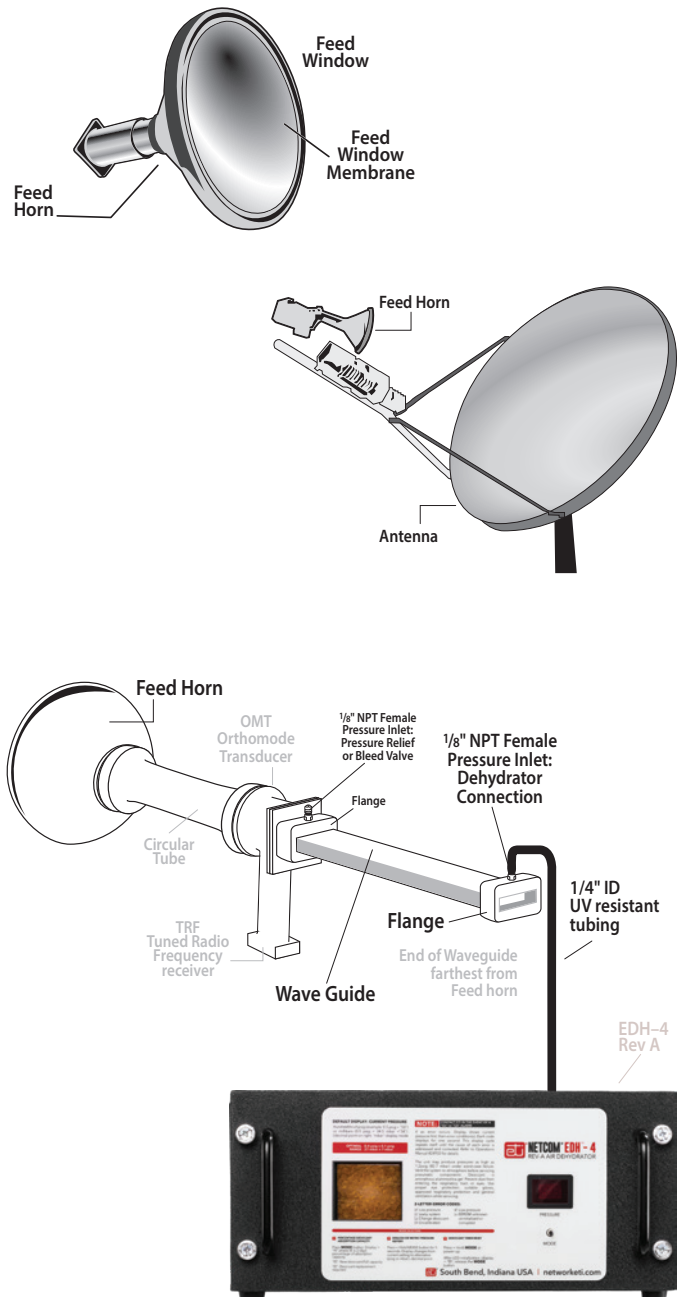

FIGURE 8. Dehydrator, waveguide, feed horn, antenna signal path

TECHNICAL DESCRIPTION

ELECTRONIC

The EDH-4 makes use of a switching power supply capable of operating over a range of input voltages.

The EDH-4 processor consists of a single integrated circuit. The processor controls pump operation to regulate system pressure, monitors electronics enclosure temperature and monitors compressor run time. The device contains an onboard EEROM (Electrically Erasable Read-Only Memory) used to accumulate compressor run time and to store the display mode.

PNEUMATIC

The pneumatic system from the pump to the unit's outlet operates at the system pressure. The air pump is a twin head vibratory pump. Air is drawn into the pump, compressed and delivered to the system. After passing through the moisture absorption unit, the air passes through a check valve. The check valve prevents reverse flow through the pump and ensures that pressure is maintained even in the event power is lost. The dried air is then delivered to the outlet.

THEORY OF OPERATION

The EDH-4 consists of a control loop managing system pressure and a second loop monitoring run time since the last desiccant replacement or regeneration. The pressure control loop is composed of the air pump, the pressure transducer and the main microprocessor. The outlet pressure is monitored. When the pressure drops to the low limit, the air pump is started and system pressure increases until the processor obtains a high limit reading from the transducer. At this point, the pump is stopped and the loop is complete.

The running time for the compressor is accumulated and stored in the EEROM. When 1,000 hours have been recorded, a Change Desiccant two-letter error code (CD) on the front panel display is issued to indicate a need to regenerate or replace the desiccant.

MAINTENANCE

PERIODIC MAINTENANCE

The EDH - 4 uses a granular desiccant consisting of Amorphous Alumino silica gel, coated with an orange iron compound indicator. The silica gel granules turn white when wet, indicating the need to regenerate or replace the desiccant. The Change Desiccant two-letter error code (CD) on the front panel display appears when 1,000 hours have accumulated on the pump. While the desiccant requires renewal every 12 to 18 months, the exact interval depends on system operational efficiency and environmental conditions. Monthly visual inspection of the desiccant is recommended.

Other than the desiccant, check the EDH-4 for dust and other particulates collecting in the cabinet; remove this debris as required.

RENEWING THE DESICCANT

Safety Note: Servicing should be performed by qualified personnel. The desiccant used in the EDH-4 Dehydrator is known as an indicating silica gel. Care should be taken to prevent the dust from entering the respiratory tract or the eyes. Utilize proper eye protection, suitable gloves. Additionally, use approved respiratory protection and general ventilation while servicing. The unit may produce pressures as high as 1.2 psig (82.7 mbar) under worst case failure. Vent the system to atmosphere before servicing pneumatic components.

The desiccant bottle on the EDH-4 is accessible behind the front panel. The steps are:

- 1 Remove power and vent system of pressurized air
- 2 Remove four (4) mounting screws from front panel (Fig. 9); open front panel (note restraint cables)
- 3 Disconnect tubing and undo straps before completely removing the bottle from the unit
- 4 Lift up and remove the desiccant bottle; open bottle cap
- 5 Regenerate (per next section) or properly dispose of the old desiccant

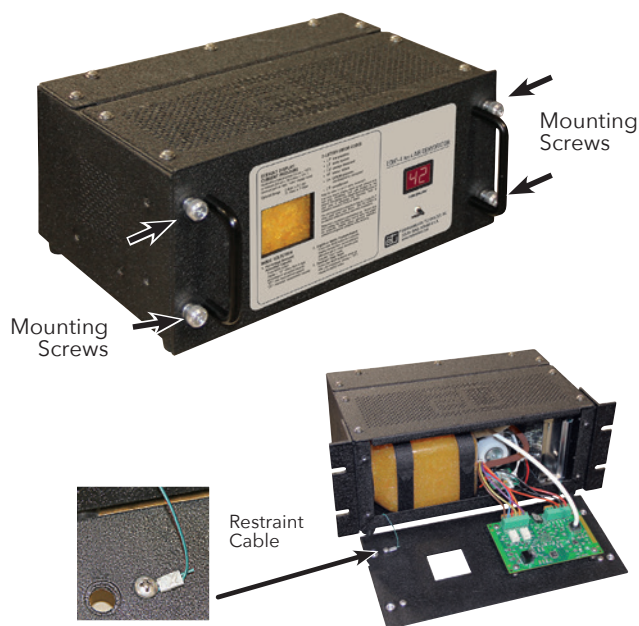
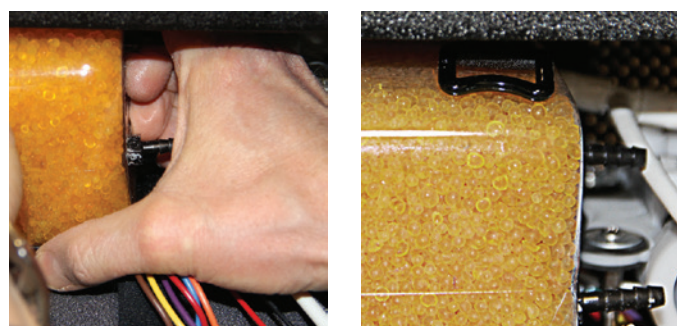
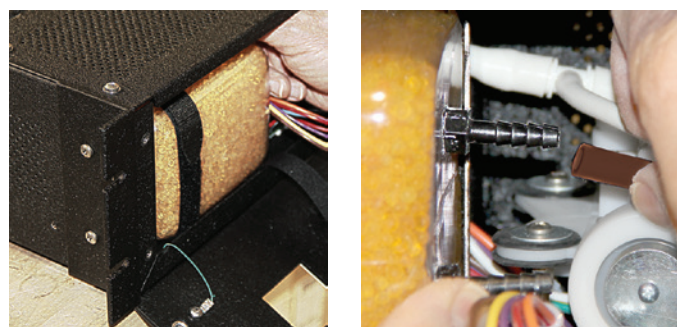
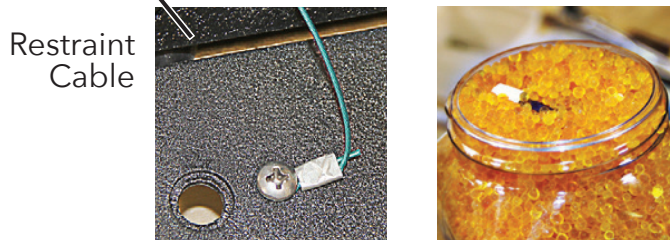
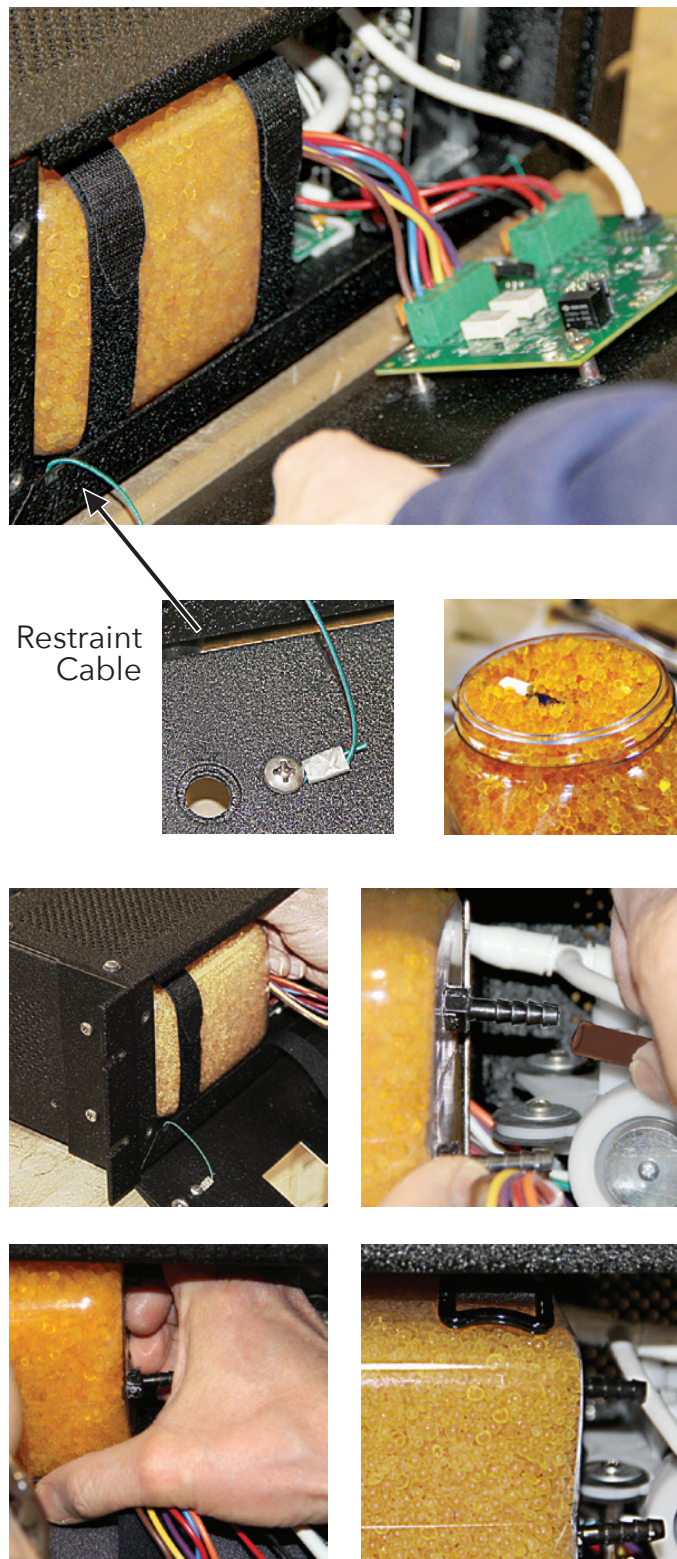

FIGURE 9. Desiccant Bottle Removal - Front Display Panel Mounting screws locations; opened front panel

FIGURE 10. Desiccant Bottle Removal - Front Display Panel, clockwise from left: Open front panel; undo straps; disconnect tubing; ready; remove bottle; open or replace



The desiccant bottle on the EDH-4 is accessible below the top panel. The steps are:

- 1 Remove power and vent system of pressurized air
- 2 Remove four (4) attachment screws from top panel (Fig. 11); lift and remove top panel
- 3 Disconnect tubing and undo straps before completely removing the bottle from the unit
- 4 Lift up and remove the desiccant bottle; open bottle cap
- 5 Regenerate (per next section) or properly dispose of the old desiccant



FIGURE 12. Desiccant Bottle Removal

1. Remove the attachment screws
2. Then remove the "ETI" Top Panel
3. Undo straps
4. Disconnect tubing from nozzles
5. Remove bottle

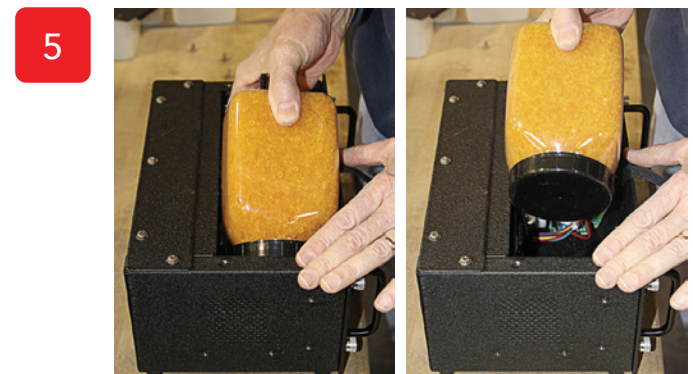
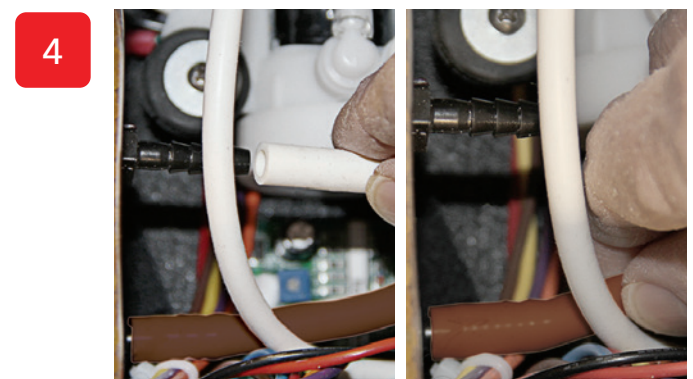
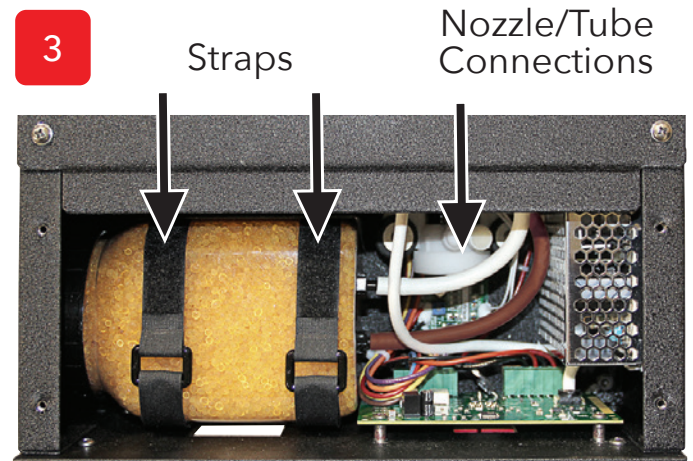

FIGURE 11. Desiccant Bottle Removal - Front Display Panel Mounting screws locations; open front panel

Replacement Desiccant

PART NUMBER	DESCRIPTION
18138	Desiccant, EDH-4 Rev A
25016	Desiccant Canister with Desiccant

When reinserting the desiccant bottle into the EDH-4, note the mark next to the nozzle on the bottom of the bottle. This mark indicates the nozzle connected to the pump with the brown tube. When returning the desiccant bottle, keep the connecting tubes flexible: this may require connections under wires and other tubes.

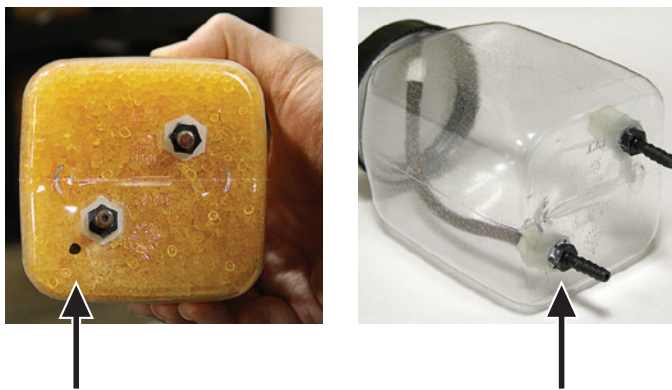
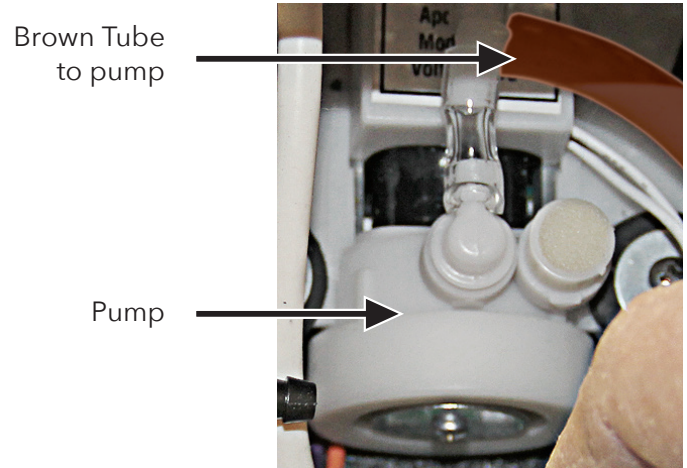
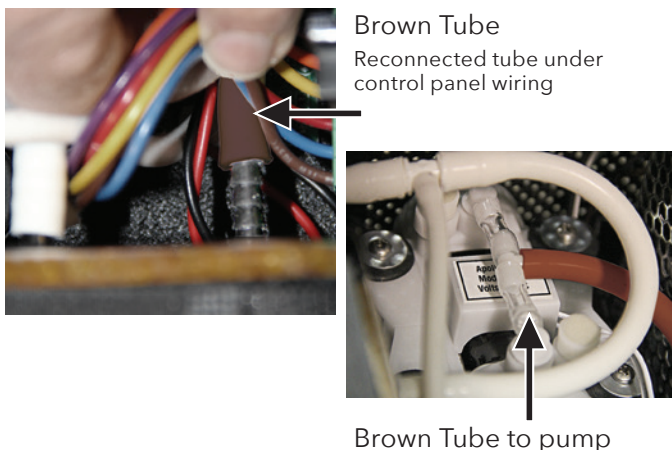

FIGURE 13. When reinstalling the desiccant bottle, confirm that the internal air distribution channel's nozzle (arrows, left), marked with a black dot next to it, is connected with the BROWN tube to the EDH-4's pump



REGENERATING THE DESICCANT

- Empty desiccant into clean baking dish
- Bake desiccant at 320°F (160°C) in a conventional oven for two hours, stirring every 30 minutes, or until silica gel particles turn orange **DO NOT USE A MICROWAVE OVEN**
- After silica gel particles have turned orange, remove desiccant from oven and allow desiccant to cool to room temperature
- As soon as it reaches room temperature, desiccant should either be returned to the desiccant bottle or placed in another airtight container to prevent its absorbing moisture from surrounding air

Fill the bottle with the new or regenerated desiccant. Reinstall the original bottle cap, confirming a tight seal. Both adapter fitting and bottle top should be secured tightly to prevent leakage which may lead to reduced desiccant service life. To test, connect brown tube from its nozzle to the pump, plug output nozzle and power up: confirm pressure does not bleed at a rate exceeding .02 psi/1.37 mbars per minute. If it does exceed this rate,

this may indicate a poor seal at the bottle cap. Slide bottle back into compartment and reattach tubing. Replace cover with screws. To reset the Desiccant Timer, press and hold [MODE] button during unit power-up; once display shows "99," reinstall access cover.

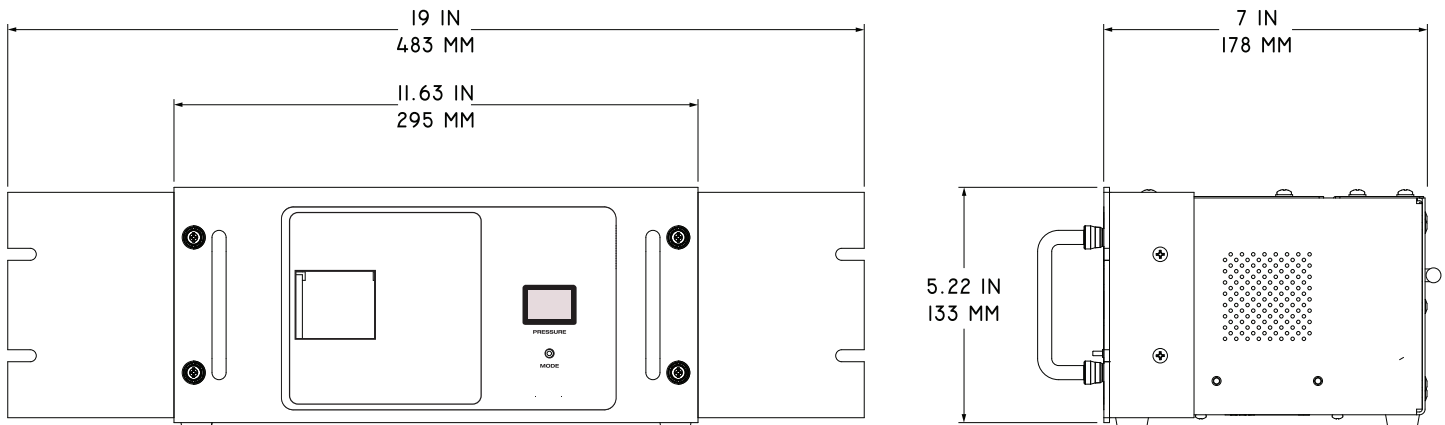

SPECIFICATIONS

OPERATION

Dehydrator Type	Non-Programmable, Single Canister,
Regeneration	Desiccant Dehydrator
Method	Manual Regeneration or Replacement
Regeneration Indication	Desiccant Color Change and Compressor Run Time
Outlet Dew Point	-40°C (New or newly regenerated desiccant) to -10°C (Desiccant requiring regeneration or replacement)
Output Pressure	0.3 - 0.5 psig (34.5 mbar)
Flow Rate	6.0 scfh (2.8 lpm)
Capacity, Standard	18 scf (510 liters)
Capacity, Max	45 scf (1,274 liters)
Discharge port	Single Port: 1/8" NPT Female (1/4" Hose Barb supplied)
Supply Voltage	100 - 240 VAC 50/60 Hz, Auto-select
Power Requirement	@120 VAC: 22 watts maximum; 8.3 watts minimum
Reliability	MTBF: 100,000 hours

INTERFACE

Air Pressure Indication	Digital Display (English or SI)
Data Display	Pressure, Estimated Desiccant Capacity Remaining, Error Codes
Communications Port	Alarm Relay
Alarm Relay Capacity	2 Amp @ 30 VDC
Relay Connection	6-position terminal block

ENCLOSURE

Dimensions	5.22" x 11.63" x 7.0" (133 mm x 295 mm x 178 mm)
Weight	7.8 pounds (3.54 kg)
Mounting	19" or 13 1/2" Rack (3U space required), wall mount, shelf or table top

ENVIRONMENTAL

Storage Temp	-40°C to 60°C
Operating Temp	0°C to 55°C

TROUBLESHOOTING

Troubleshoot the EDH-5 Air Dehydrator using the information below.

PROBLEM (ALARM CONDITION)	ACTION	COMMENTS
Nothing works	Verify the unit has power.	Ensure supply power is available to the unit.
LP Low Pressure	Disconnect feed tube from air outlet.	Pump should operate continuously.
	If no pump operation, check pump electrical connections.	Pump has failed or circuit board has failed.
	Block the air outlet and verify whether the unit reaches the correct operating pressure. If continued no or low pressure with air outlet blocked, check internal air path for leaks or blockage.	If no blockage or leakage is detected, the pump or the circuit board has failed.
	Check external air path for leakage.	
Check air flow through pump inlet filter.		
LE Leaky System	If unit pressure reads less than 0.2 psig (16.8 mbar), check internal air path for leakage.	If no blockage or leakage is detected, the pump or the circuit board has failed.
	Check external air path for leakage.	
	If pressure reads more than 0.5 psig (37.5 mbar), check the air path inside the unit for blockage.	
CD Desiccant Renewal Required	Visually inspect desiccant bottle. If the silica particles are orange, reset the desiccant alarm by pressing [MODE] while powering up the unit. Note that resetting the desiccant alarm will restart the counter to 1,000 hours. Monthly inspections are suggested.	The [MODE] pushbutton is located just below the PRESSURE LED display.
	If the silica particles are white, renew the desiccant.	Refer to the Maintenance section of this manual.
HF Low Temperature	Verify that the electronic enclosure temperature is above 5°C. If the equipment room temperature is below 0°C, allow the unit to run for 30 to 60 minutes to allow the enclosure's internal automatic heater to raise the internal temperature.	Should clear alarm condition unless circuit board has failed.
UN Initialization Error	Reset the desiccant timer, as described for the Cd alarm. Cycle power to see if it worked.	Circuit board has failed.
CA Calibration Error	Uncalibrated.	EEROM has not been set. Call Customer Service.

REPLACEMENT PARTS LIST

PART NUMBER	DESCRIPTION
18138	Replacement Desiccant
25016	Desiccant Canister with Desiccant

ORDERING INFORMATION

ORDER NUMBER	DESCRIPTION
18021	EDH-4 Low Cost Air Dehydrator (Revision A)
25016	Replacement Desiccant Canister with Desiccant for EDH-4 (Revision A)
18138	Replacement Desiccant, 32 ounces (0.95 liters)
25415	Netcom EDH-4 Quick-Reference Installation Guide
18063	Netcom EDH-4 Installation & Operation Manual (this document) available online at: networketi.com/product-manuals

LIMITED WARRANTY

ETI's two year limited warranty covering defects in workmanship and materials applies. Contact Customer Service for complete warranty information.

DISCLAIMER

ETI makes no representations or warranties, either expressed or implied, with respect to the contents of this publication or the products that it describes, and specifically disclaims any implied warranties of merchantability or fitness for any particular purpose. ETI reserves the right to revise this publication and to make changes and improvements to the products described in this publication, without the obligation of ETI to notify any person or organization of such revisions, changes or improvements.

RETURNS AND REPLACEMENT PARTS PURCHASES

Prior to removing equipment for return, please contact ETI at (800) 234-4239 for troubleshooting assistance.

Before returning the unit to Environmental Technology, Inc., obtain a Return Material Authorization (RMA) number from our Customer Service Department between 8:00 a.m. and 5:00 p.m. Eastern Time (UTC minus five hours) at (574) 233-1202 or (800) 234-4239.